

AJH12A

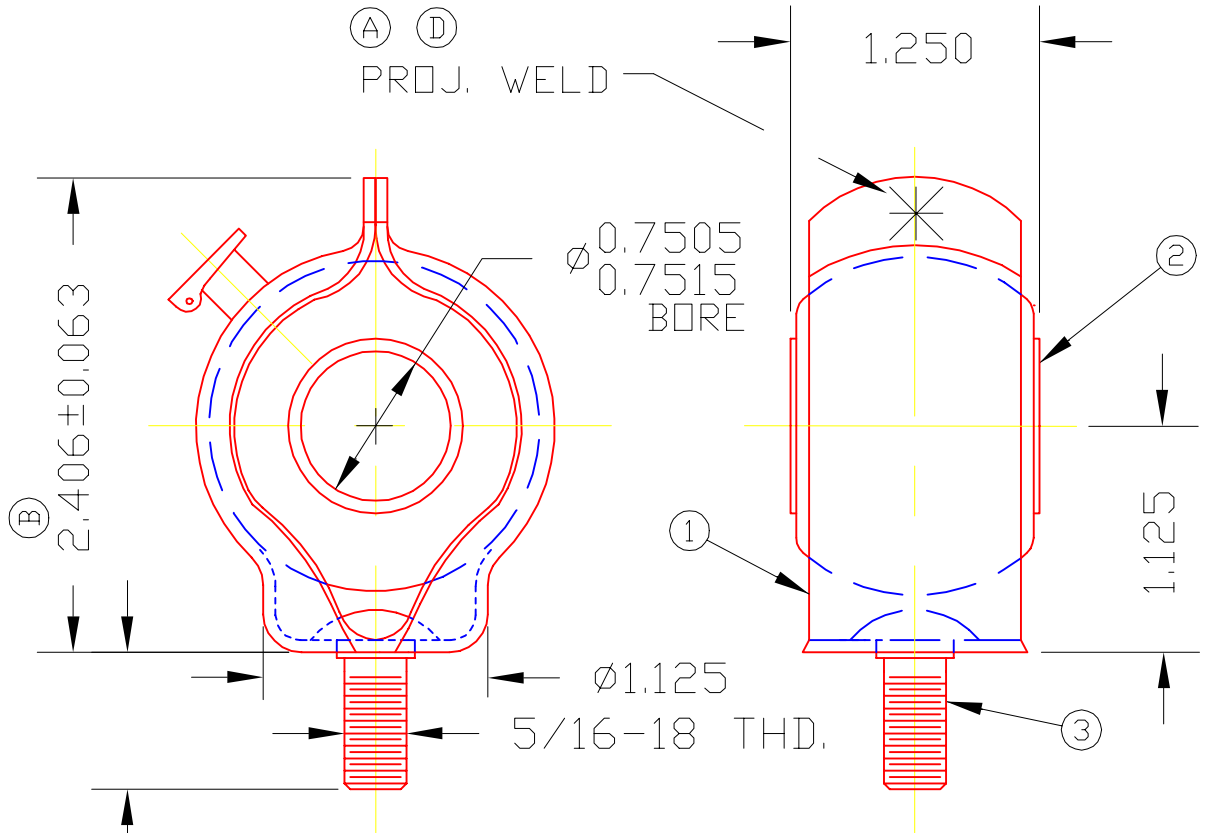

3	1891	BOLT	1
2	H12A	BRG. BALL	1
1	1843	MOUNTING	1

DET	PART NUMBER	DESCRIPTION	AMT
-----	-------------	-------------	-----

A TRIANGLE MANUFACTURING CO.
OSHKOSH, WI.

NAME CLAM SHELL BRG.

USED IN AJ SERIES

DATE	8-1-62	PART NO.	AJH12A
DRAWN	BW-88		
CHECKED	SP		
SCALE	1 / 1		

LUB	OIL T.M.C. #L1
PLATING	GALV.
MATERIAL	SEE DETAILS
ALL DIMS ± 0.02 UNLESS SPECIFIED	

CHANGE LEVEL
G 07-27-04