

AJH16G

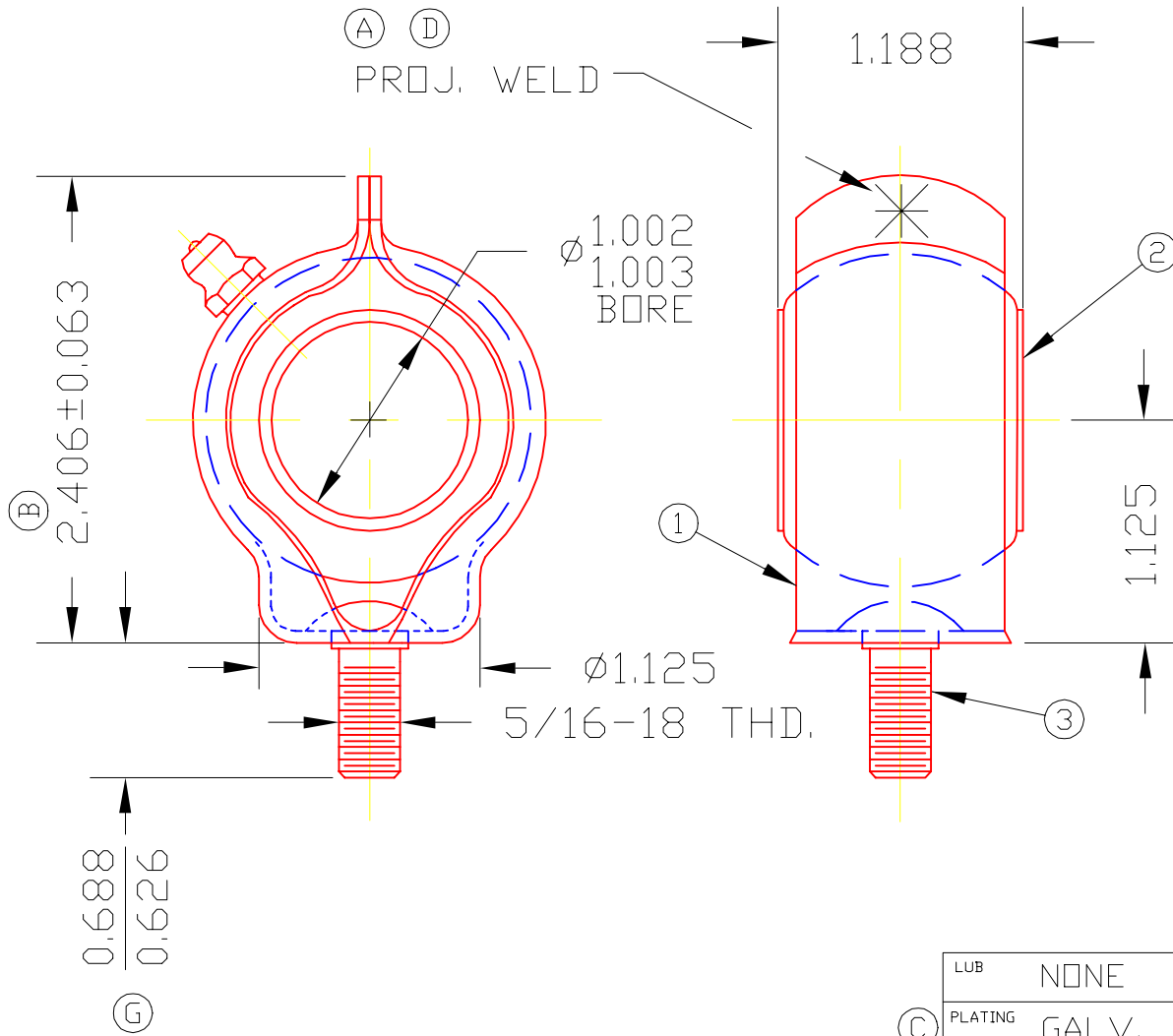

3	1891	BOLT	1
2	H16G	BRG. BALL	1
1	1843	MOUNTING	1
DET	PART NUMBER	DESCRIPTION	AMT

A TRIANGLE MANUFACTURING CO.
OSHKOSH, WI.

NAME CLAM SHELL BRG.

USED IN AJ SERIES

DATE 8-2-62

PART NO.

DRAWN BW-88

CHECKED SP

SCALE 1 / 1

AJH16G

(C)

LUB	NONE
PLATING	GALV.
MATERIAL	SEE DETAILS
ALL DIMS ±.02 UNLESS SPECIFIED	

CHANGE LEVEL
G 07-27-04