

EEE18J

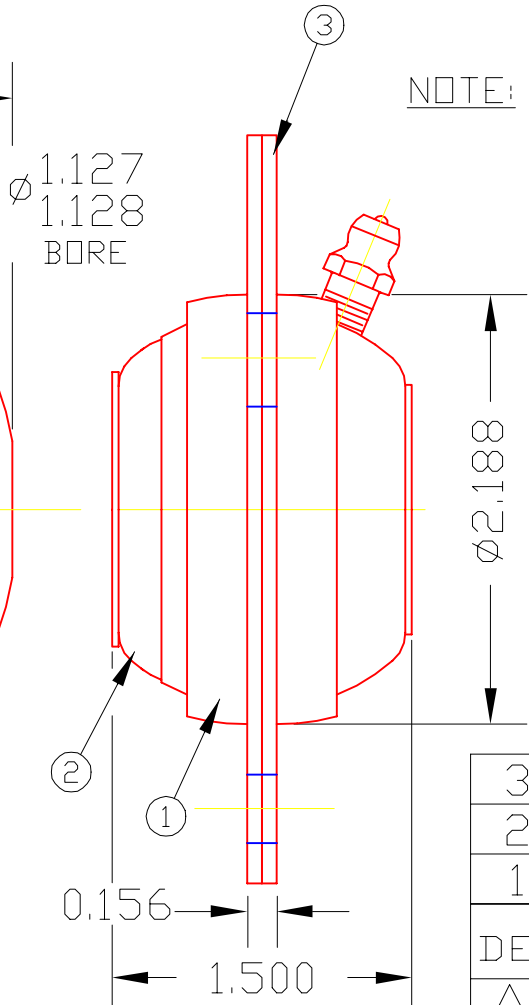
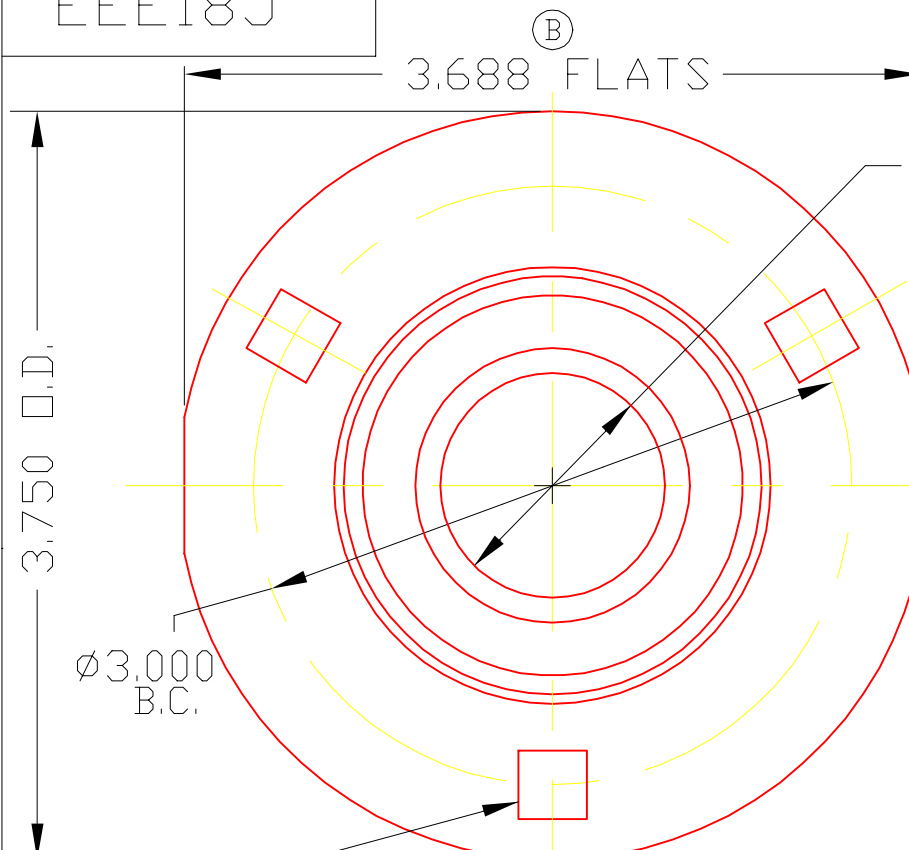

NOTE: SHIPPED AS UNASSEMBLED COMPONENT PARTS

3	2794	FLANGE-NOTCH	1
2	E18J	BRG. BALL	1
1	2793	FLANGE	1

DET	PART NUMBER	DESCRIPTION	AMT
-----	-------------	-------------	-----

A TRIANGLE MANUFACTURING CO.
OSHKOSH, WI.

NAME CENTER FLANGE BRG.

USED IN EE SERIES

DATE 5-31-63 PART NO.

DRAWN BW-88

CHECKED SP

SCALE 1 / 1

EEE18J

©

LUB	NONE
PLATING	GALV
MATERIAL	SEE DETAILS
ALL DIMS ±.02 UNLESS SPECIFIED	

CHANGE LEVEL
C 12-26-73