

CK1408P

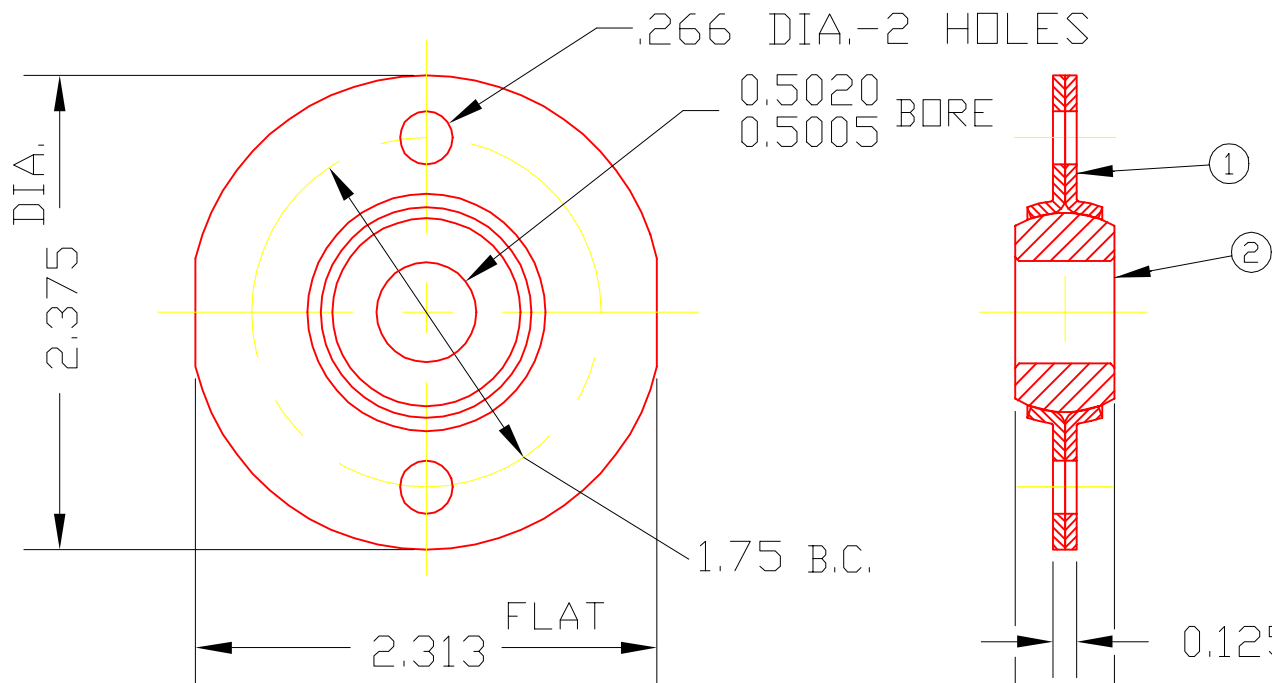

NOTE: SHIPPED AS
UNASSEMBLED
COMPONENT PARTS

2	1408P	BRG. BALL	1
1	1701	BRACKET	2
DET	PART NUMBER	DESCRIPTION	AMT
A TRIANGLE MANUFACTURING CO. OSHKOSH, WI.			

NAME CENTER FLANGE BRG.

USED IN CK-SERIES

DATE 7-1-70

PART NO.

DRAWN SP

CHECKED SP

SCALE 1 / 1

CK1408P

(A)

LUB.	OIL
PLATING	GALV
MATERIAL	SEE DETAILS
ALL DIMS ±.02 UNLESS SPECIFIED	

CHANGE LEVEL
A 11-29-73