

CKN12

NOTE: SHIPPED AS
UNASSEMBLED
COMPONENT PARTS

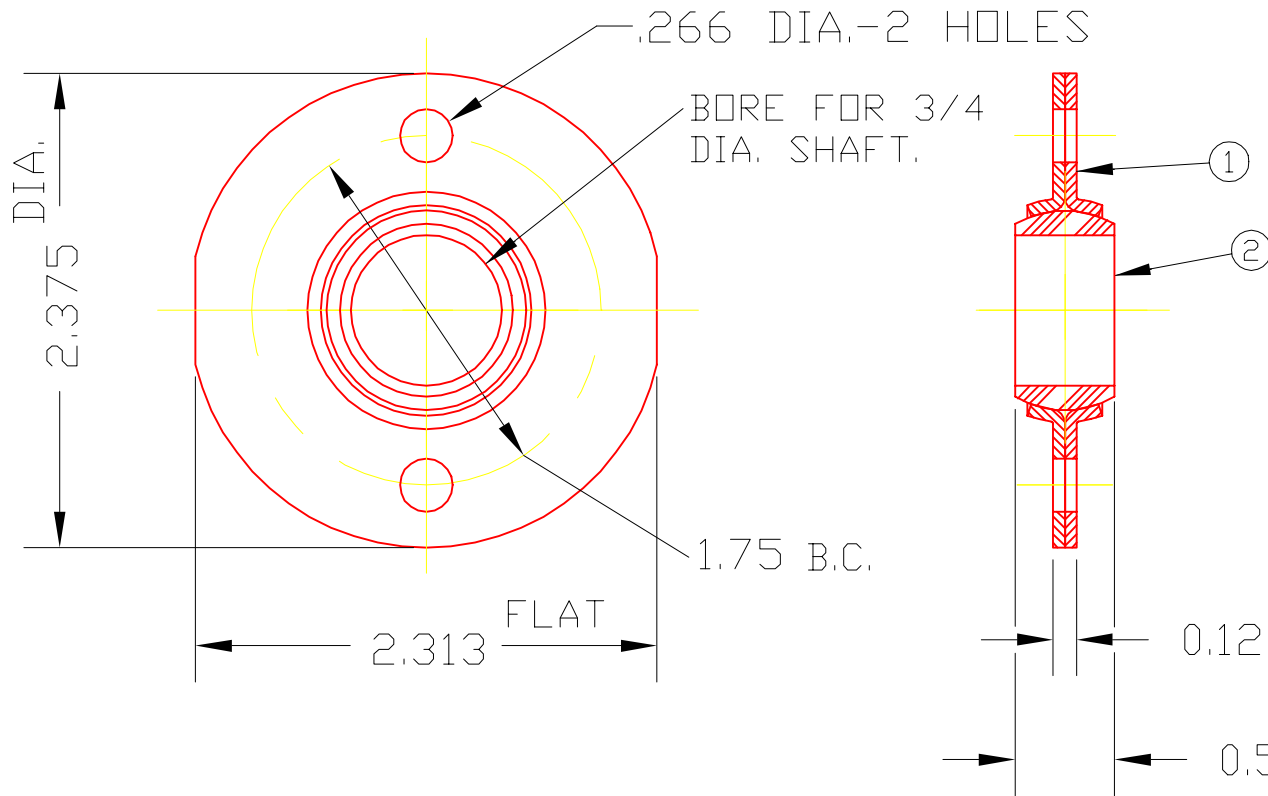

2	N12	BRG. BALL	1
1	1701	BRACKET	2
DET	PART NUMBER	DESCRIPTION	AMT
A TRIANGLE MANUFACTURING CO. OSHKOSH, WI.			

LUB.	
PLATING	GALV
MATERIAL	SEE DETAILS
ALL DIMS ±.02 UNLESS SPECIFIED	

NAME	CENTER FLANGE BRG.
USED IN	CK-SERIES
DATE	8-29-61
DRAWN	SP
CHECKED	SP
SCALE	1 / 1
PART NO.	CKN12

CHANGE LEVEL	
C	11-29-73