

CK1510P

NOTE: SHIPPED AS
UNASSEMBLED
COMPONENT PARTS

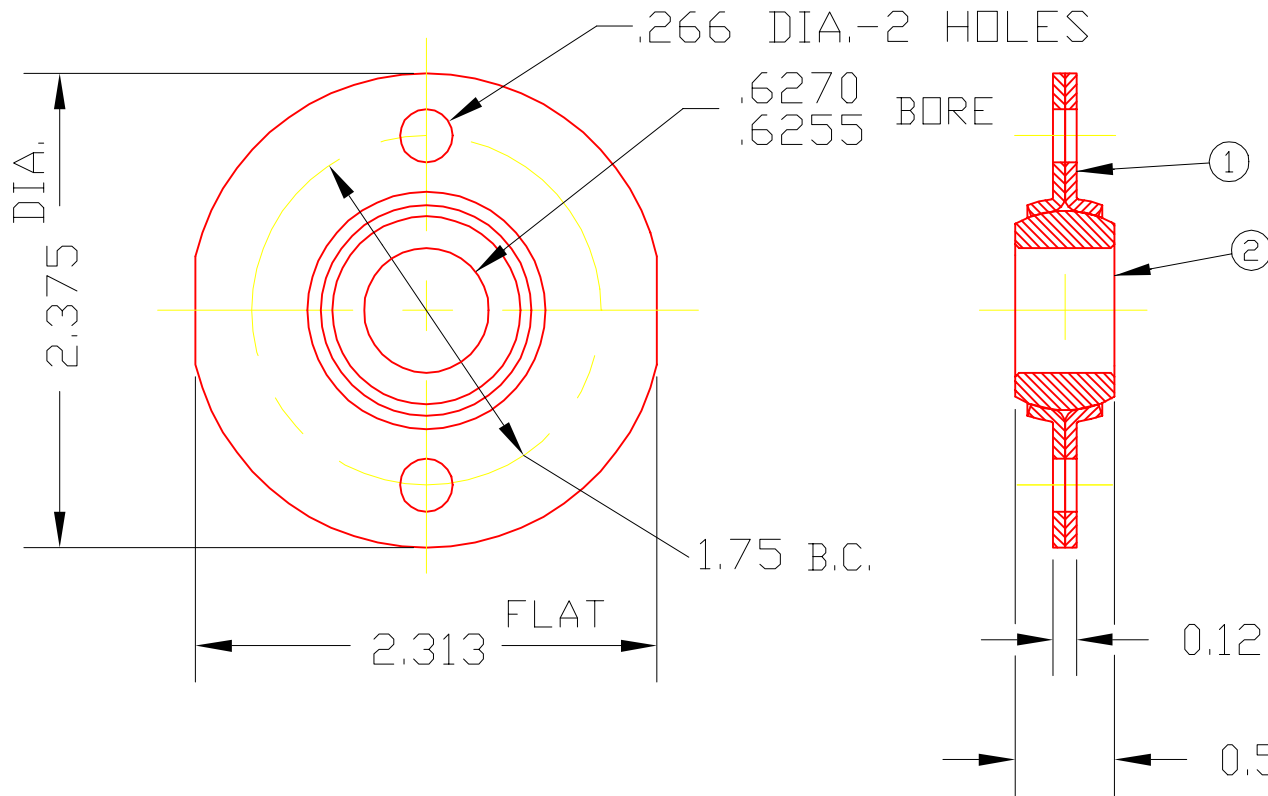

2	1510P	BRG. BALL	1
1	1701	BRACKET	2
DET	PART NUMBER	DESCRIPTION	AMT
A TRIANGLE MANUFACTURING CO. OSHKOSH, WI.			

LUB.	OIL
PLATING	GALV
MATERIAL	SEE DETAILS
ALL DIMS ±.02 UNLESS SPECIFIED	

NAME	CENTER FLANGE BRG.
USED IN	CK-SERIES
DATE	3-14-66
DRAWN	SP
CHECKED	SP
SCALE	1 / 1
PART NO.	CK1510P

CHANGE LEVEL
A 11-29-73