

GAH14A

NOTE: SHIPPED AS
UNASSEMBLED
COMPONENT PARTS

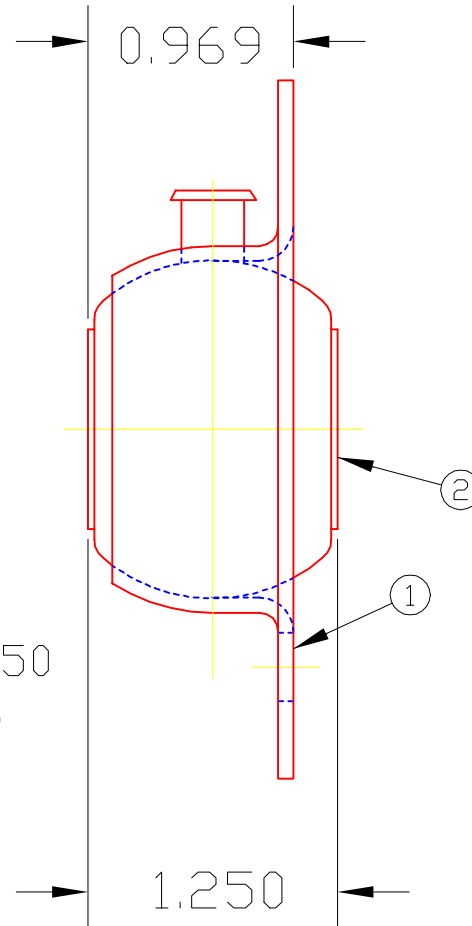
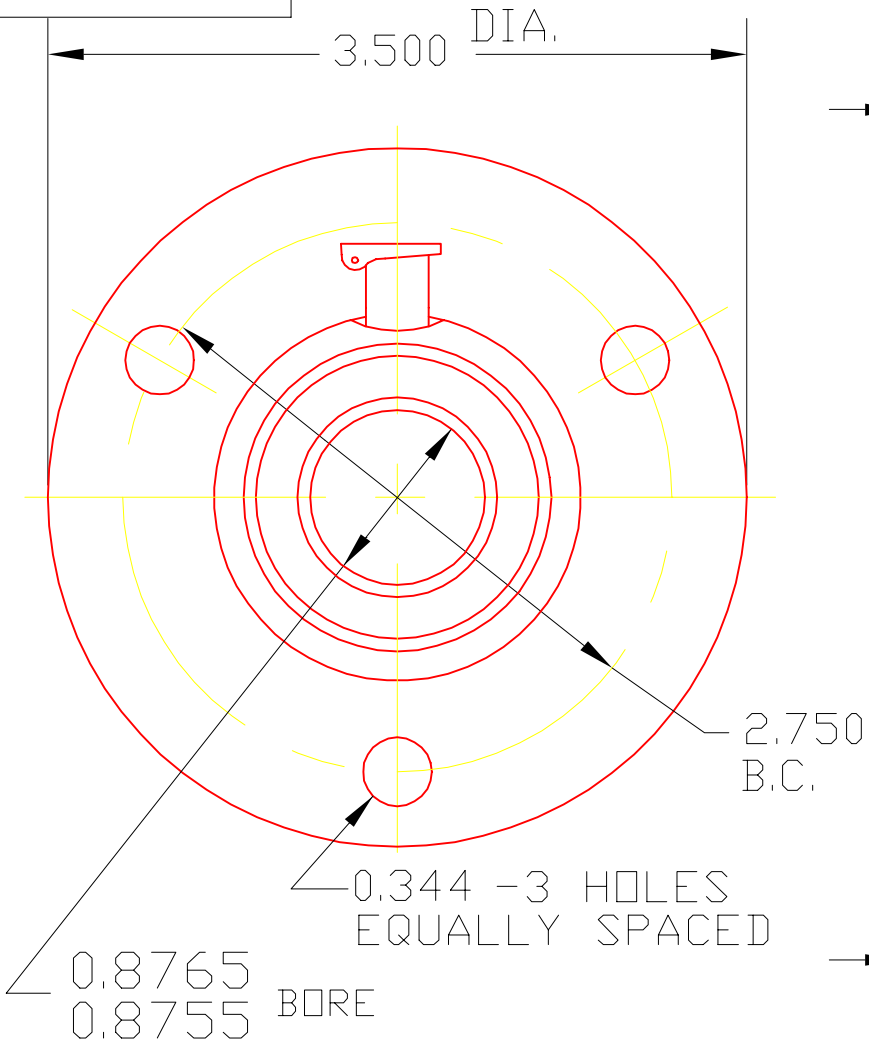

2	H14A	BALL ASS'Y	1
1	1769	MOUNTING	1
DET	PART NUMBER	DESCRIPTION	AMT

A TRIANGLE MANUFACTURING CO.
OSHKOSH, WI.

NAME MID FLANGE BRG.

USED IN GA-SERIES

DATE 5-18-61

PART NO.

DRAWN SP

CHECKED SP

SCALE 1 / 1

GAH14A

LUB. OIL-T.M.C. #L-1

PLATING GALV.

MATERIAL SEE DETAILS

ALL DIMS ±.02 UNLESS SPECIFIED

CHANGE LEVEL

- / - / -