

GAH8A

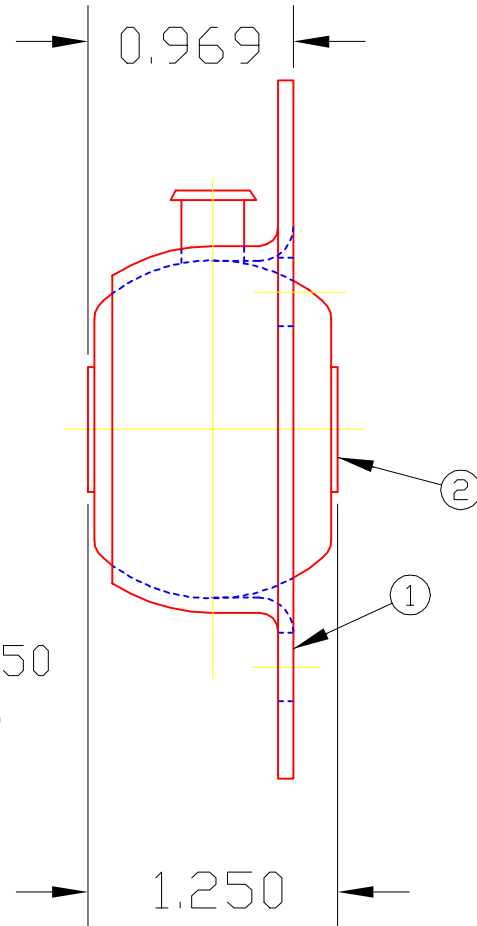
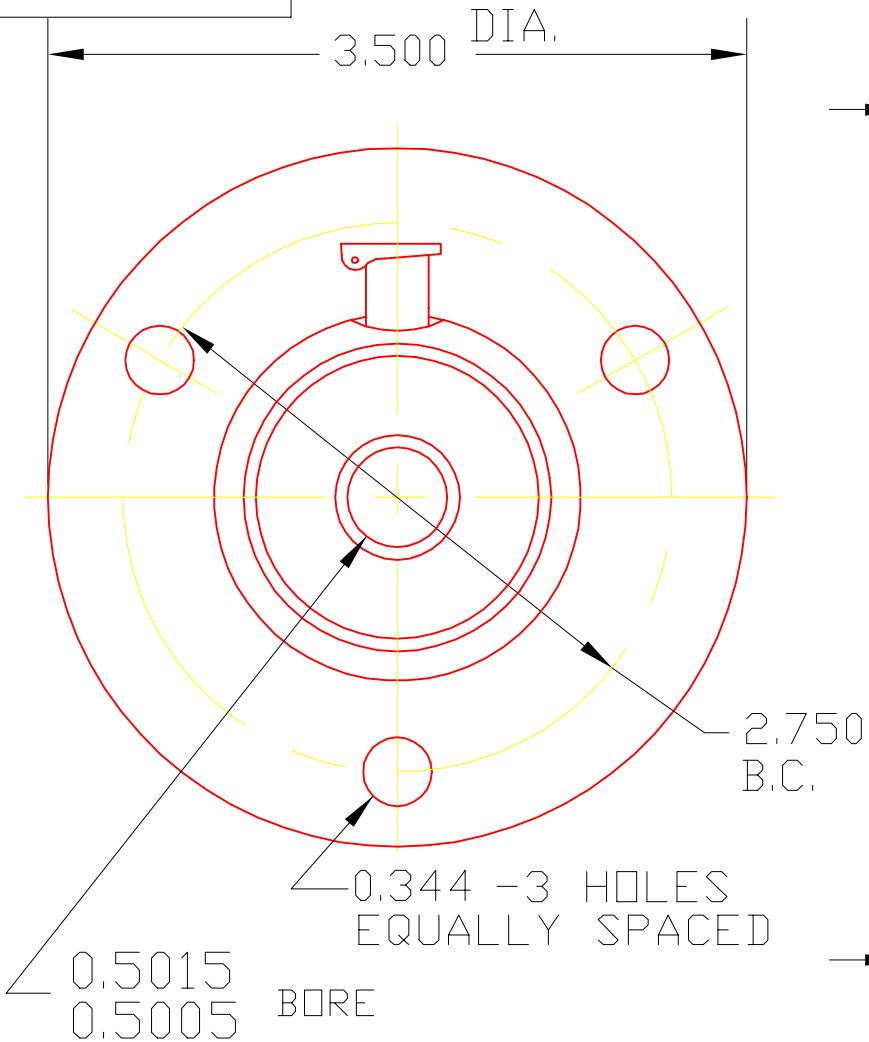

NOTE: SHIPPED AS UNASSEMBLED COMPONENT PARTS

2	H8A	BALL ASS'Y	1
1	1769	MOUNTING	1
DET	PART NUMBER	DESCRIPTION	AMT
A TRIANGLE MANUFACTURING CO. OSHKOSH, WI.			

NAME MID FLANGE BRG.	
USED IN GA-SERIES	
DATE 5-18-61	PART NO.
DRAWN SP	GAH8A
CHECKED SP	
SCALE 1 / 1	

LUB.	OIL-T.M.C. #L-1
PLATING	GALV.
MATERIAL	SEE DETAILS
ALL DIMS ±.02 UNLESS SPECIFIED	

CHANGE LEVEL			
-	-	-	-