

GBH14A

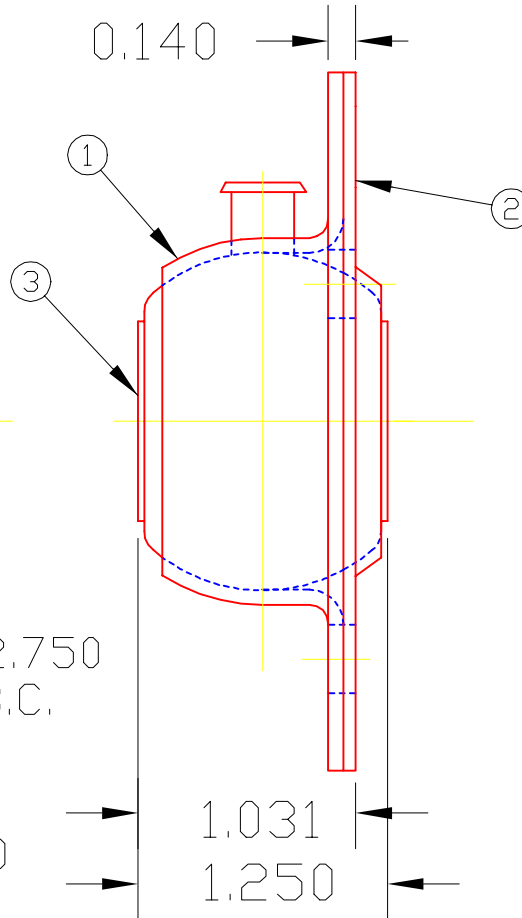
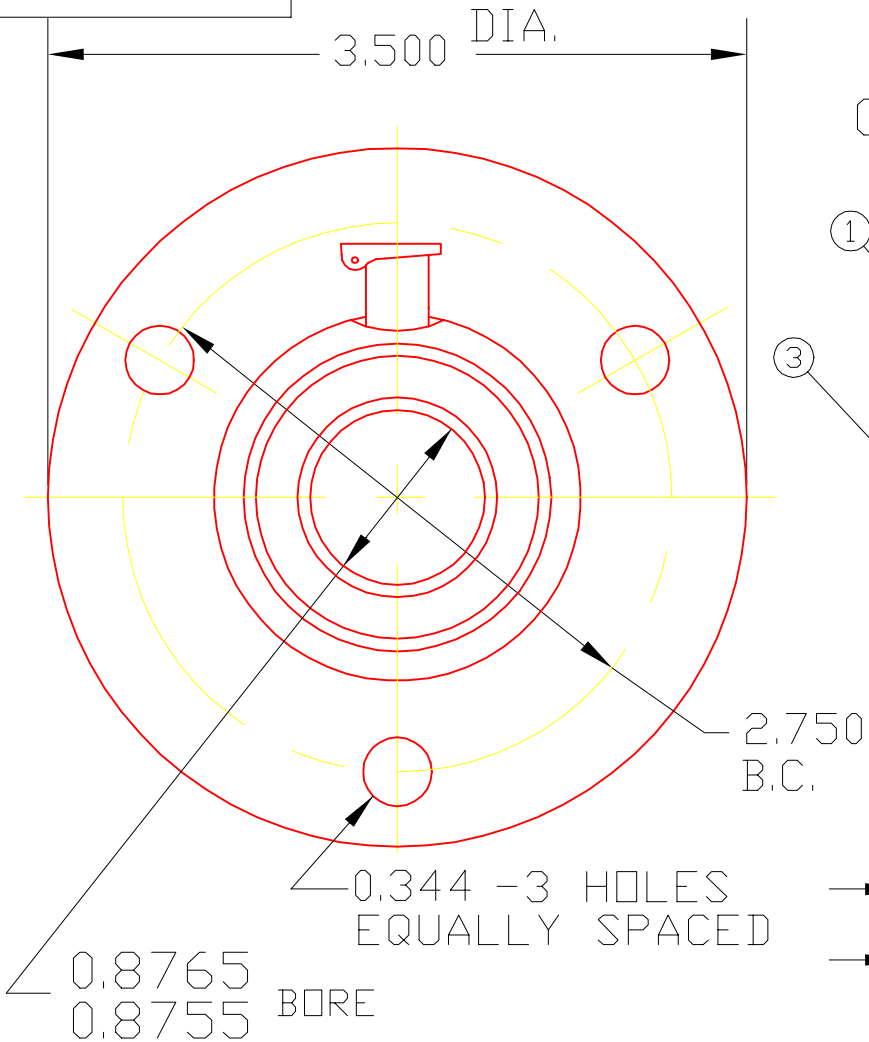

NOTE: SHIPPED AS
UNASSEMBLED
COMPONENT PARTS

3	H14A	BALL BRG.	1
2	1898	BACK PLATE	1
1	1769	MOUNTING	1

DET	PART NUMBER	DESCRIPTION	AMT
-----	-------------	-------------	-----

△ TRIANGLE MANUFACTURING CO.
OSHKOSH, WI.

NAME MID FLANGE BRG.

USED IN GB-SERIES

DATE 11-20-61 PART NO.

DRAWN SP

CHECKED SP

SCALE 1 / 1

GBH14A

LUB. OIL-T.M.C. #L-1

PLATING GALV.

MATERIAL SEE DETAILS

ALL DIMS ±.02 UNLESS SPECIFIED

CHANGE LEVEL	
A	2-25-74