

FEE15G

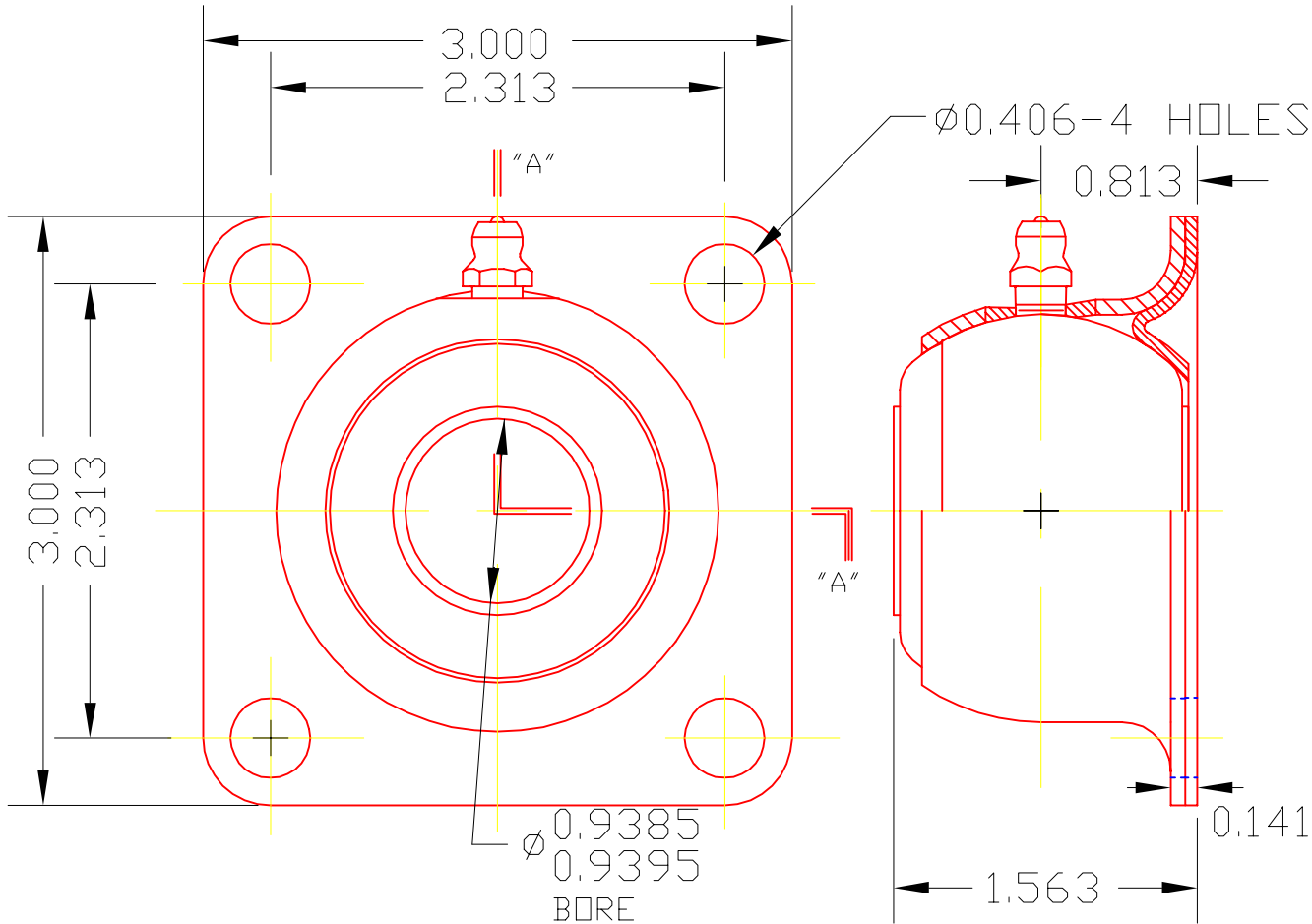

3	E15G	BALL ASS'Y	1
2	1051	BASE	1
1	1050	CONTAINER	1

DET	PART NUMBER	DESCRIPTION	AMT
-----	-------------	-------------	-----

△ TRIANGLE MANUFACTURING CO.
OSHKOSH, WI.

NAME4 BOLT SIDE FLANGE BRG

USED IN FE MTG.

DATE 3-1-60 PART NO.

DRAWN BW-88
CHECKED SP

SCALE 1 / 1

FEE15G

LUB	NONE
PLATING	GALV.
MATERIAL	SEE DETAILS
ALL DIMS. ±.020 UNLESS OTHERWISE SPECIFIED	

CHANGE LEVEL
A 1-22-74