

FEE16A

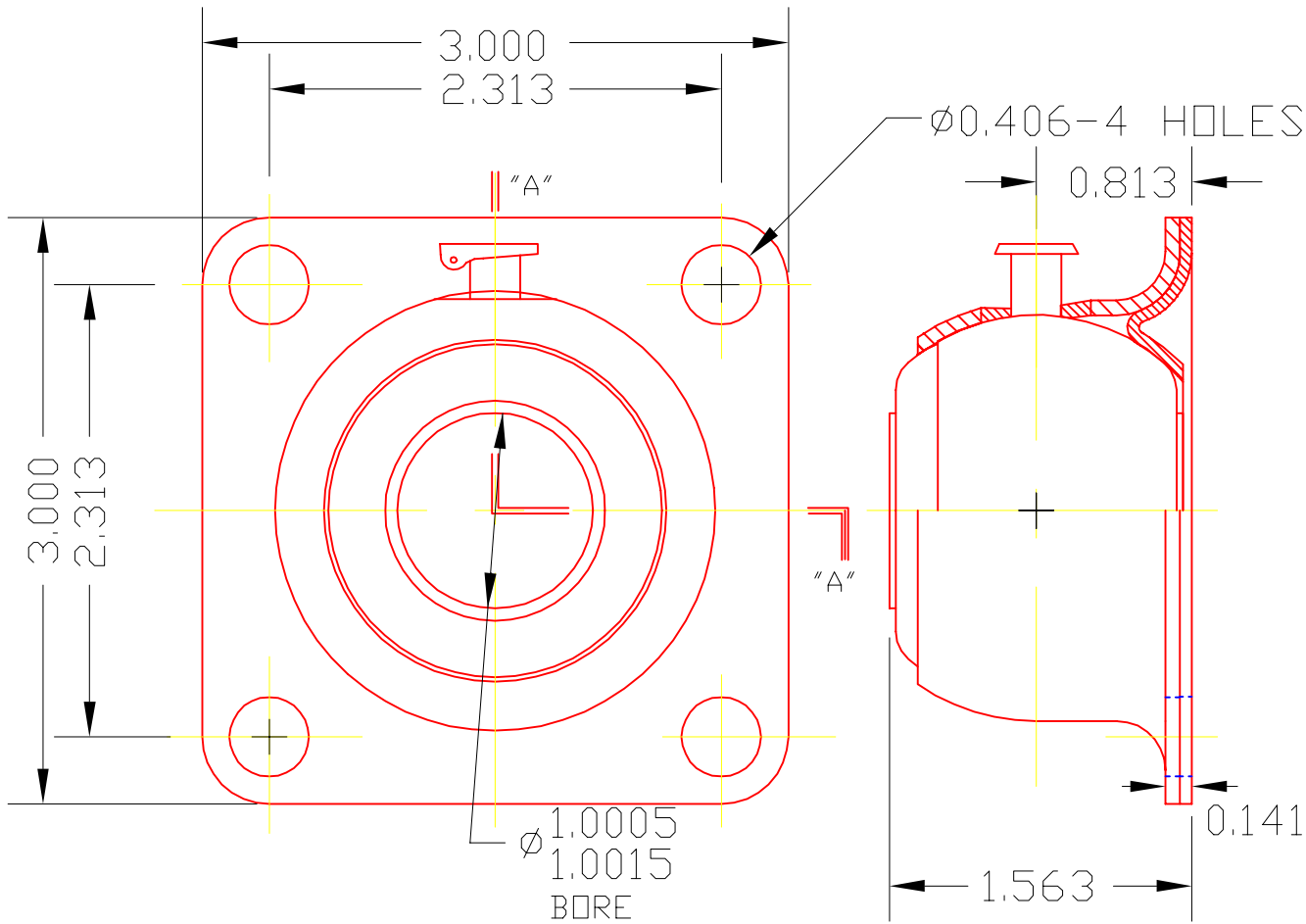

3	E16A	BALL ASS'Y	1
2	1051	BASE	1
1	1050	CONTAINER	1

DET	PART NUMBER	DESCRIPTION	AMT
-----	-------------	-------------	-----

△ TRIANGLE MANUFACTURING CO.
OSHKOSH, WI.

NAME4 BOLT SIDE FLANGE BRG

USED IN FE MTG.

DATE	3-1-60	PART NO.
DRAWN	BW-88	
CHECKED	SP	

SCALE 1 / 1

FEE16A

LUB	OIL T.M.C. #L1
PLATING	GALV.
MATERIAL	SEE DETAILS
ALL DIMS. ±.020 UNLESS OTHERWISE SPECIFIED	

CHANGE LEVEL
A 1-22-74