

FM1508P

NOTE: ASSEMBLY TO FIT GAGE THAT HAS
.250 DIA. PINS ON 1.750±.001 CENTERS.

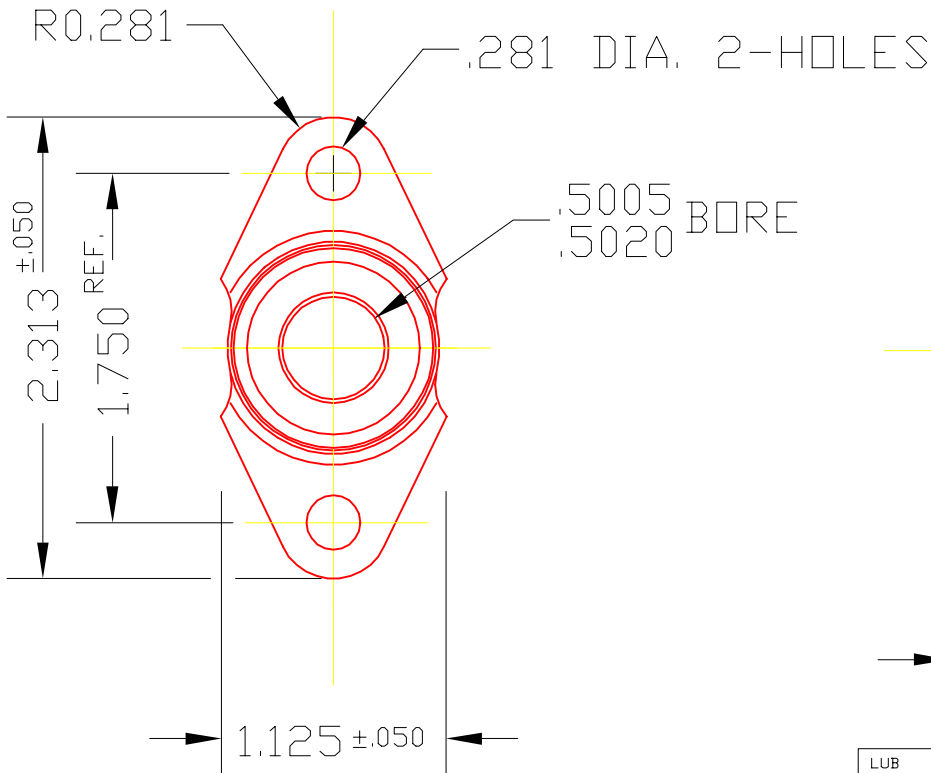

PART IDENTIFY WITH TRIANGLE
NAME STAMP

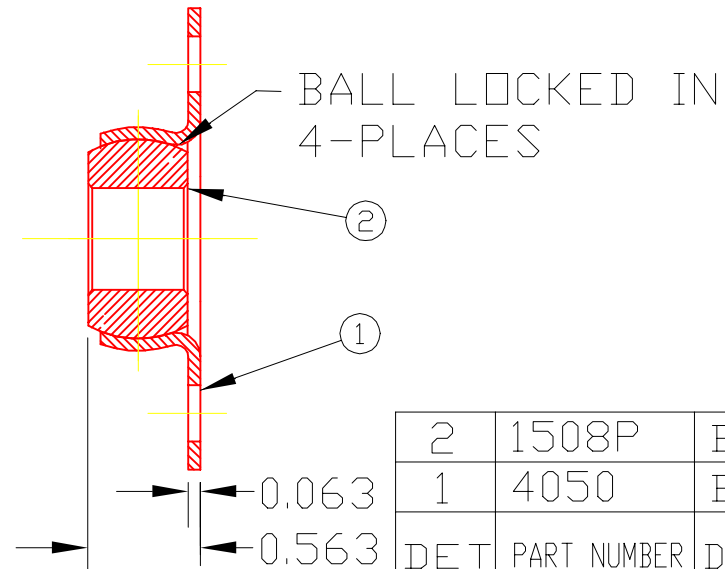

DET	PART NUMBER	DESCRIPTION	AMT
2	1508P	BRG. BALL	1
1	4050	BRACKET	1

▲ TRIANGLE MANUFACTURING CO.
OSHKOSH, WI.

LUB	OIL
FIT	SNUG TO TIGHT
PLATING	GALV.
MATERIAL	SEE DETAILS
ALL DIMS ±.020 UNLESS SPECIFIED	

NAME SIDE FLANGE BRG. ASS'Y	
USED IN FM SERIES	
DATE	3-22-68
DRAWN	SP
CHECKED	SP
SCALE	1 / 1
PART NO. FM1508P	

CHANGE LEVEL	
F	8-22-89