

BJE14A

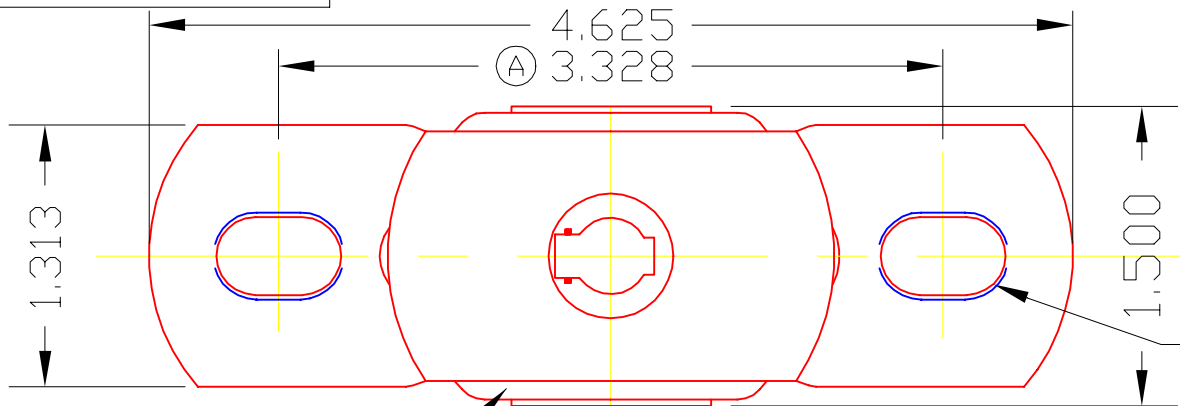

2 SLOTS
0.391 WIDE X 0.594 LONG (E)

SLOTS IN BASE & CONTAINER MAY
HAVE SLIGHT MISALIGNMENT IN THE
LONG DIRECTION. (D)

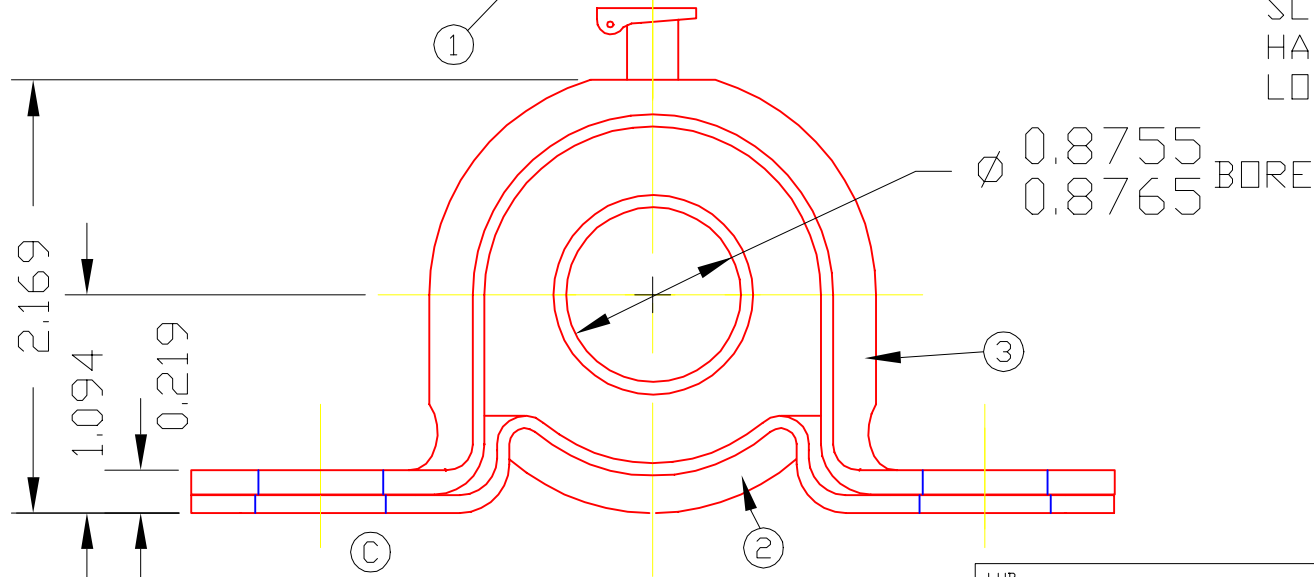

3	E14A	BALL ASS'Y	1
2	1048	STRAP	1
1	1047	BASE	1

DET	PART NUMBER	DESCRIPTION	AMT
-----	-------------	-------------	-----

A TRIANGLE MANUFACTURING CO.
OSHKOSH, WI.

NAME PILLOW BLOCK ASS'Y

USED IN BJ SERIES

DATE 7-31-62

PART NO.

DRAWN BW-88

CHECKED SP

SCALE 1 / 1

BJE14A

CHANGE LEVEL
E 06-10-03

LUB.	OIL T.M.C. #L1
PLATING	GALV.
MATERIAL	SEE DETAILS
ALL DIMS. ± 0.020 UNLESS OTHERWISE SPECIFIED	