

N6

NOTE - PARTING LINE OF DIE
TO BE IN CENTER OF 0.094 FLAT
FOR MOLD FIN RELIEF

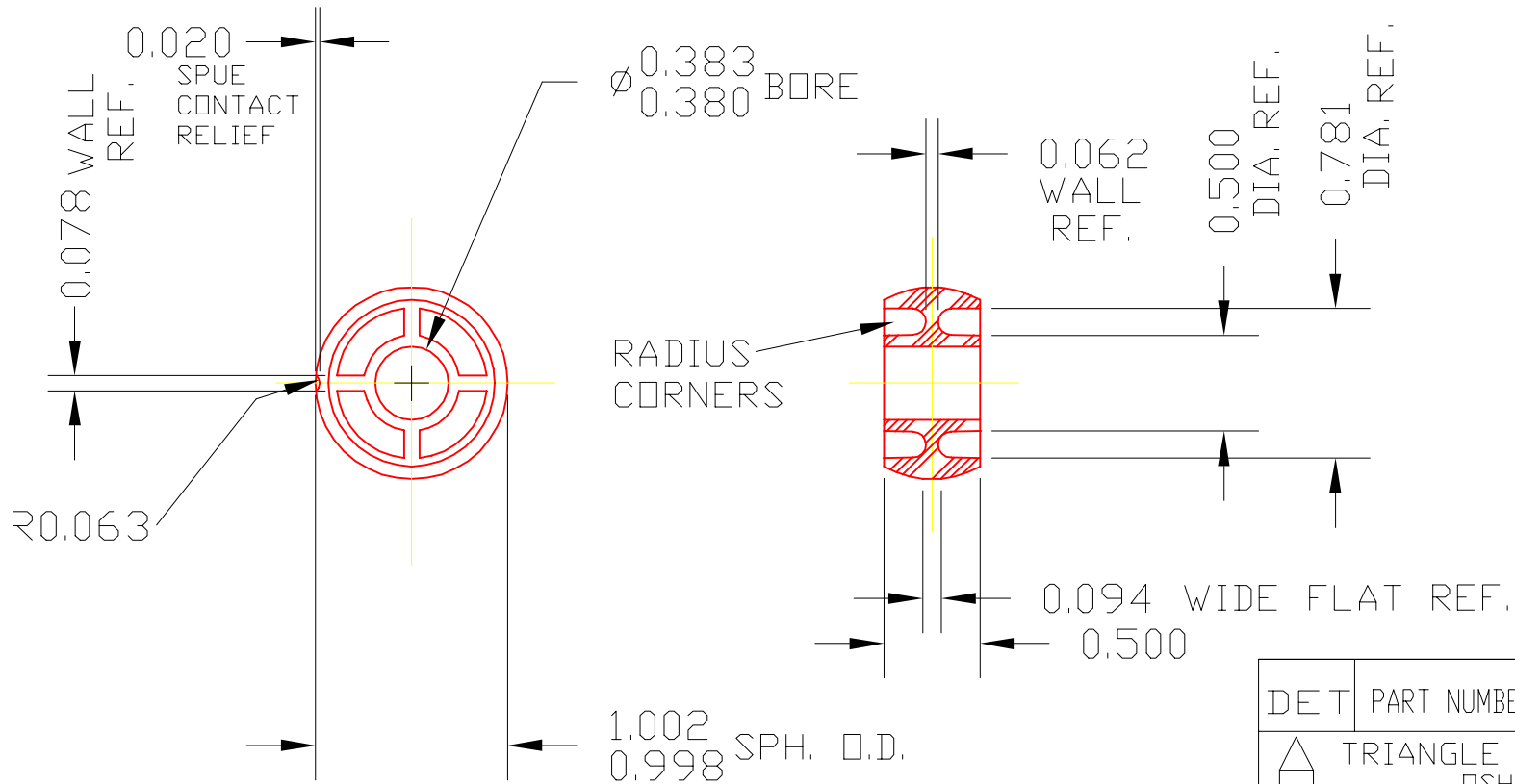

DET	PART NUMBER	DESCRIPTION	AMT
A		TRIANGLE MANUFACTURING CO. OSHKOSH, WI.	
NAME BEARING BALL-PLASTIC			
USED IN N SERIES			
DATE	9-19-63	PART NO.	
DRAWN	LML	N6	
CHECKED	////		
SCALE	1 / 1		

FIT	////
PLATING	////
MATERIAL	NYLON #101
ALL DIMS ±.020 UNLESS SPECIFIED	

CHANGE LEVEL	
B	02-21-94